

Instruction Manual for MANO CLAMP

Attached with an inspection card

Edition for 2018

Important:

**Prior to use of the product, be
sure to read and understand this
document.**



Table of contents

Signal Words -----	1
Precautions for Use -----	2
Structure and Operating Principle -----	7
Movement of Clamp and Operating Principle -----	8
Actuator Replacement -----	10
Actuator Replacement Principle -----	11
Basic Specification -----	12
Procedure for Shaping Jaws -----	13
Jaw Reshaping Procedure -----	15
Procedure for Attaching the Actuator and Cylinder -----	16
Bolt Tightening Torque -----	17
Procedure for Replacing the Actuator -----	18
Using the Rotary Union -----	20
Air Purge of the Rotary Union -----	22
Operation System Diagram -----	23
Precautions for Attaching the Rotary Union -----	24
Warranty of MANO CLAMP -----	25
Troubleshooting -----	26
Data Sheet for MANO CLAMP -----	27

Signal Words



Indicates an imminently hazardous situation which, if not avoided, will result in death or serious injury.



Indicates a potentially hazardous situation which, if not avoided, could result in death or serious injury.

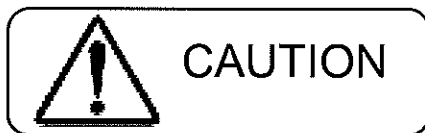

Indicates a potentially hazardous situation which, if not avoided, may result in minor or moderate injury.



Precautions for Use

To attach, replace, or lubricate MANO CLAMP, previously turn OFF the power.

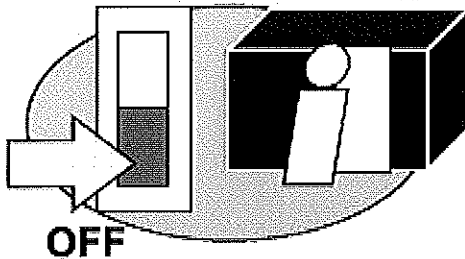

If the spindle, tool rest, grinding wheel, or the like moves, the operator is exposed to very hazardous risks.

During spindle rotation, do not use the opening/closing valve.

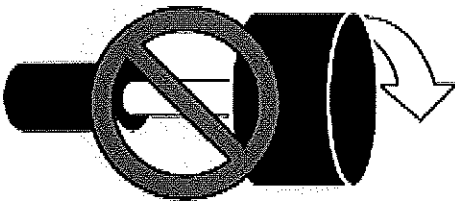

This is very dangerous as the workpiece would be ejected.

The MANO CLAMP cannot be used beyond the maximum number of revolutions.

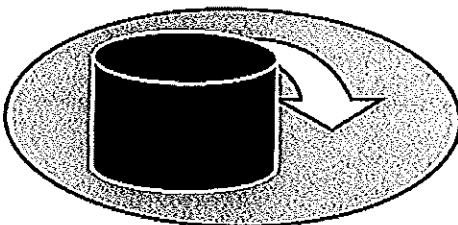

A centrifugal force generated from the number of revolutions may cause a clamping force to become insufficient. This is very dangerous as a workpiece would be ejected.



The product cannot be used exceeding the upper limit of the supplied air pressure.

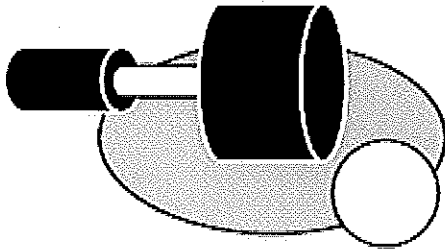

The parts for MANO CLAMP may be damaged during machining, causing the workpiece and those parts to be scattered around.

Do not open/close the door of the machine until the spindle is completely stopped.

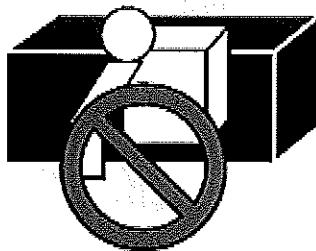

MANO CLAMP, the workpiece, machining chip, or the like might cause an accident resulting in injury or death.

Considering possible power interruption due to power failure or any other reason, use a check valve to maintain the air pressure.

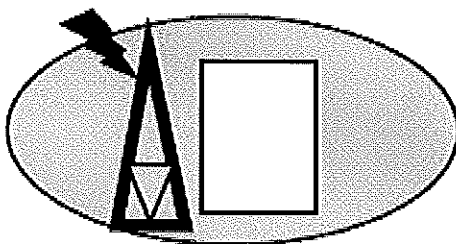

The workpiece might be ejected, causing an accident resulting in injury or death or damage to the machine or other equipment.



To tighten attaching screws and other parts, use the specified torque.

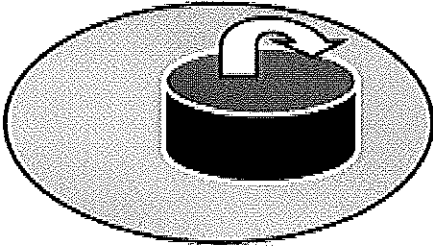

If MANO CLAMP or its parts come off and are scattered around during rotation, the operator is exposed to very hazardous risks.

When jaws higher than the standard height are used, the clamping torque decreases.

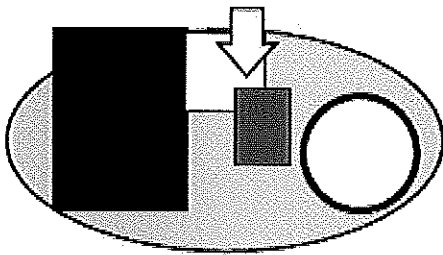

Design and handle the jaws so that the proper state can be maintained within the operating air pressure for the MANO CLAMP.

Avoid any modification to MANO CLAMP as it results in a hazardous situation.

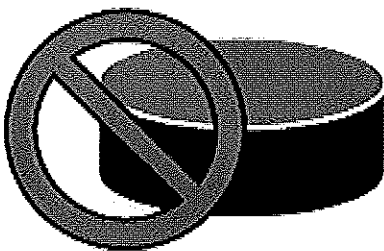

Never give any modification to MANO CLAMP as it causes various hazards including decreased force and air leakage.



Do not operate the machine after drinking or taking a medicine.

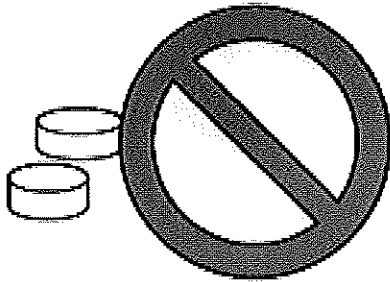

Avoid drinking alcohol, taking any medicine that has a sleep-inducing effect, or using any cannabis, narcotic or stimulant drug, or the like.

During operation, do not use any wear that is easily caught by the machine.

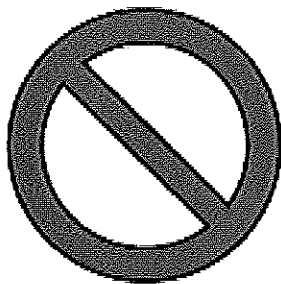

Avoid using any necktie, gloves, or low-bottom jacket, which is easily caught by the machine.



In clamping a workpiece with MANO CLAMP, take care not to get your finger or hand clamped.

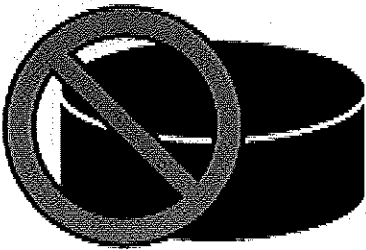

This may result in serious injury such as cutting off your finger or hand. Make the operator well aware of this potential hazard.

Do not hit MANO CLAMP or its part with a tool or the like.

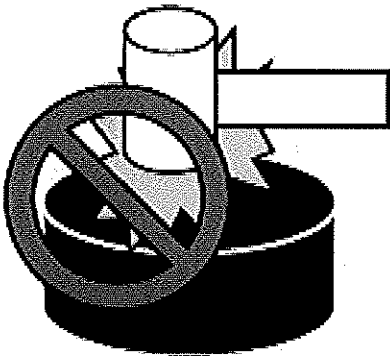

The chuck might be damaged or its precision might deteriorate.

For centering, use a resin hammer or the like.

Structure and Operating Principle

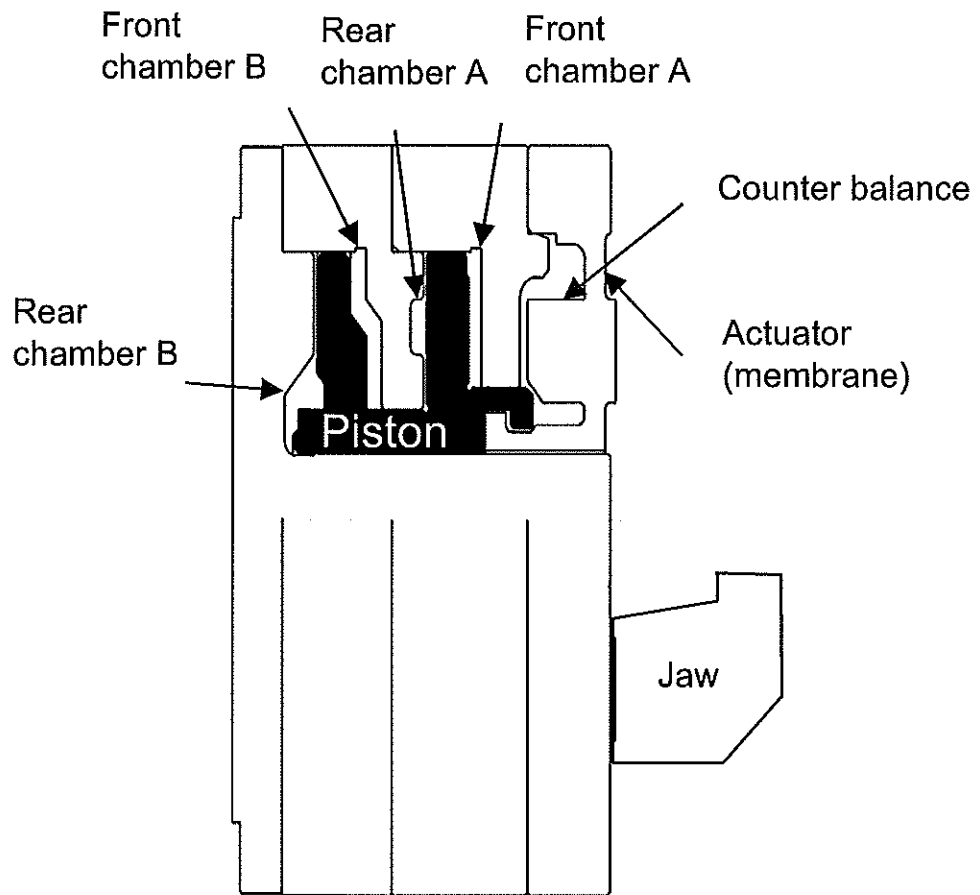

Movement of Clamp and Operating Principle

(Example of O.D. Clamping)

1. Air is sent to rear chambers A and B.
2. The piston moves to the right side in the above figure while pushing and inflating the actuator (a workpiece can be inserted by sending higher air pressure than the jaw finishing pressure).
3. The workpiece is inserted.
4. By releasing the air from rear chambers A and B, the actuator clamps the workpiece with its membrane still inflated due to the previously applied jaw finishing pressure. The actuator's clamping force depends on the amount of membrane inflation.
5. In order to ensure the sufficient clamping force, a counter balance, a back pressure (reduction force), and a lead-in (increased force) mechanism are incorporated.

For outer-diameter clamping

By increasing the number of revolutions, the mass of a jaw changes into a centrifugal force, thus working in the direction of weakening a clamping force. Then, by placing a weight on the back side of the actuator, this generates a force in the direction of eliminating a centrifugal force of a jaw.

Back pressure (reduction force)

In step 5, the air is released from rear chambers A and B. Subsequently, pressure is applied to these chambers at pressure lower than the jaw finishing pressure depending on the situation. (The jaws' clamping force decreases as this pressure becomes closer to the jaw finishing pressure.) This operation provides a solution for excessive clamping force without requiring remachining the workpiece at lower jaw finishing pressure.

Lead-in (increased force)

In Step 4, the air is released from Rear Chambers A and B. At this time, air is oppositely supplied at a proper pressure into Front Chambers A and B. (Higher pressure becomes an increased force.) This operation shall be regarded as counter-measures against a weak clamping force.

Actuator Replacement

Light weight.
High-speed
rotation
specification

Applicable type
for multiple
jaws

Replacement
version of
actuator with
jaws

Actuator with inner
diameter clamping jaws

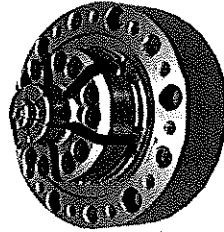

Actuator with jaws

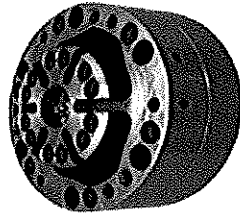

Actuator with outer
diameter clamping jaws

Cylinder

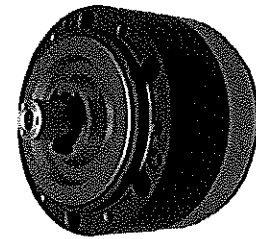

Patent No. 3346718

Actuator Replacement Principle

The actuator and the piston have their respective hooks with notches. Align these notched positions, insert the actuator and rotate it 60°. This completes the engagement.

This mechanism enables setup from the membrane.

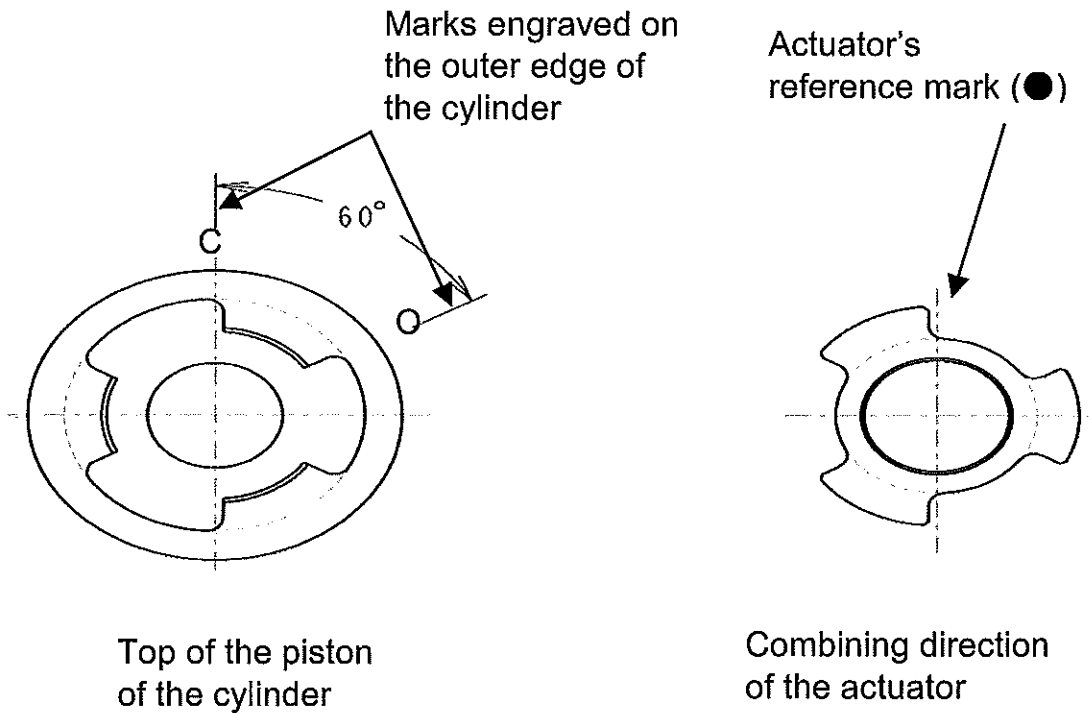

Normal: The cylinder's engraved mark (C) and the actuator's mating mark (●) are engaged at the identical position.

Release: The cylinder's engraved mark (O) and the actuator's mating mark (●) are engaged at the identical position.

Basic Specification

(For the dimensions of the MANO CLAMP's main body, see a catalog.)

Category	Conditions Type	Theoretical outer-diameter clamping force at jaw height of 15H [tightening allowance at 0.3MPa (jaw-finishing pressure)]		Total jaw strokes at a jaw height of 15H	Rule of thumb for MANO CLAMP's clamping diameters	
		Elastic-membrane clamping force only N (kgf)	Total jaw-clamping force* N (kgf)	Supply pressure at 0.5MPa (standard product) (dia.)	Outer-diameter clamping (dia.)	Inner-diameter clamping (dia.)
For cutting	NM-2.7SB-6	539 (55)	1,029 (105)	0.5	3-40	8-40
	NM-2.7WB-6	539 (55)	1,401 (143)	0.4	3-40	8-49
	NM-3WB-6LT	882 (90)	2,303 (235)	0.3	3-50	8-50
	NM-3TB-6LV	1,136 (116)	2,842 (290)	0.2	3-50	8-50
	NM-4SA-6 NM-4SB-6KG	1,450 (148)	2,352 (240)	0.2	3-68	10-68
	NM-4WB-6	1,430 (146)	3,626 (370)	0.2	3-68	10-68
	NM-4TB-6	1,744 (178)	4,508 (460)	0.2	3-68	10-68
	NM-5SA-6 NM-5SB-6	2,391 (244)	4,481 (457)	0.4	3-89	10-89
	NM-5WB-6	2,254 (230)	5,742 (586)	0.3	3-89	10-89
	NM-6WB-6	2,861 (292)	7,500 (765)	0.2	3-100	15-100
	NM-8WB-630	4,900 (500)	12,446 (1,270)	0.2	3-140	20-140
	NM-10WT-655	7,663 (782)	19,031 (1,942)	0.2	3-200	30-200

*: Including an increased-force operating force (at 0.5 MPa).

Procedure for Shaping Jaws

1. Attach the blank jaw to MANO CLAMP with hex socket head cap bolts. Coat the mounting bolts with Loctite 242 and then tighten them with a torque wrench.

For 6 jaws, mate the No. 1 jaw with a mating mark on the actuator, and align all jaws clockwise.

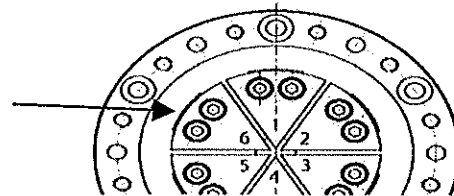

For the tightening torque, see page 17.

2. Attach MANO CLAMP to a machine tool. (For attaching MANO CLAMP, see Basic Attachment on page 20.)

Pneumatic piping

Attach the rotating union securely to the chuck. (For using the rotating union, see page 20.)

Carry out piping with the precision regulator installed in the circuit to make the air pressure variable.

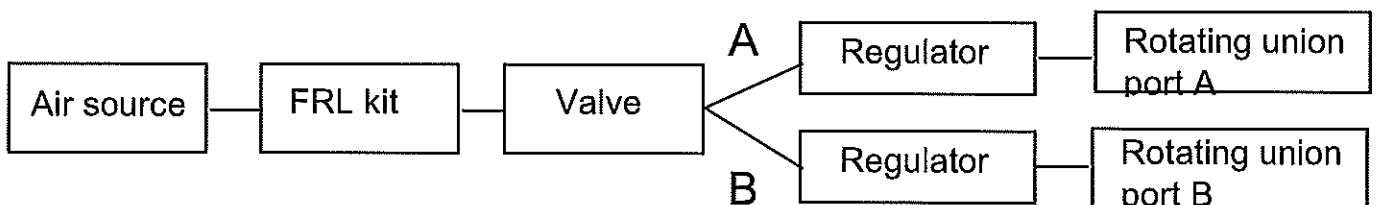

Setting the jaw finishing pressure and loader clearance

For O.D. clamping, finish the jaws by gradually changing the difference between the air source and jaw finishing pressures in units of 0.05 MPa.

For I.D. clamping, gradually change the jaw finishing pressure in units of 0.05 MPa.

Example: For O.D. clamping, use 0.4 MPa (port A) as the standard setting.

Example: For I.D. clamping, use 0.1 MPa (port A) as the standard setting.

Finish the jaws.

Considering the loader clearance, initially finish the jaws so that the clamping force increases as much as possible. If the clamping force is too strong, refinish the jaws to decrease the clamping force.

Jaw Reshaping Procedure

■ Setting the air pressure

Set the air pressure to the value used for the previous finishing.

■ Cutting the jaws

For O.D. clamping:

Cut the jaws to the specified diameter while reducing the air pressure. Record the jaw finishing pressure and diameter. Continue to decrease the air pressure until the entire jaw surfaces are finished. (In this case, the clamping force decreases.)

For I.D. clamping:

Cut the jaws to the specified diameter while increasing the air pressure. Continue to increase the air pressure until the entire jaw surfaces are finished. (In this case, the clamping force decreases.) Record the jaw finishing pressure and diameter.

Procedure for Attaching the Actuator and Cylinder

Note: For centering, use a plastic hammer.

1. Checking the attaching surface

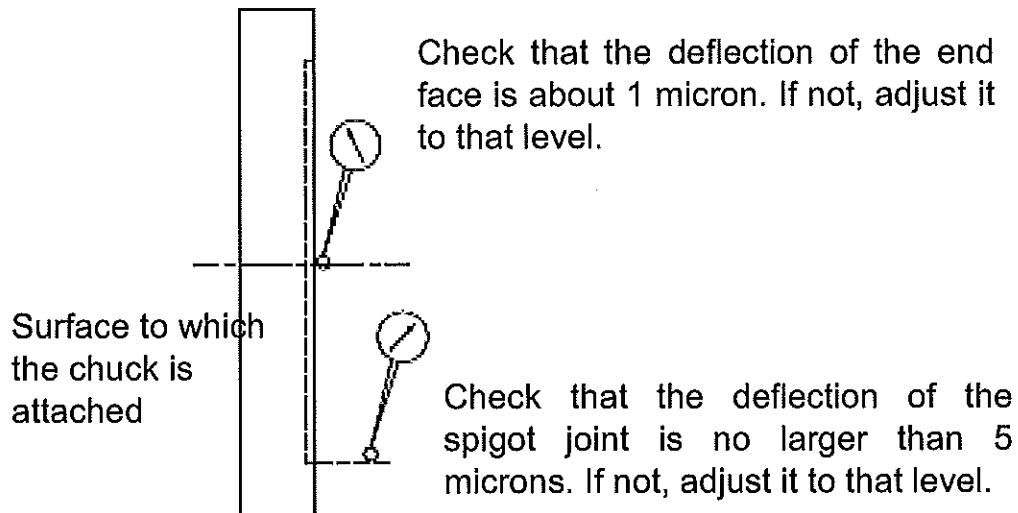

2. Attaching and centering the cylinder

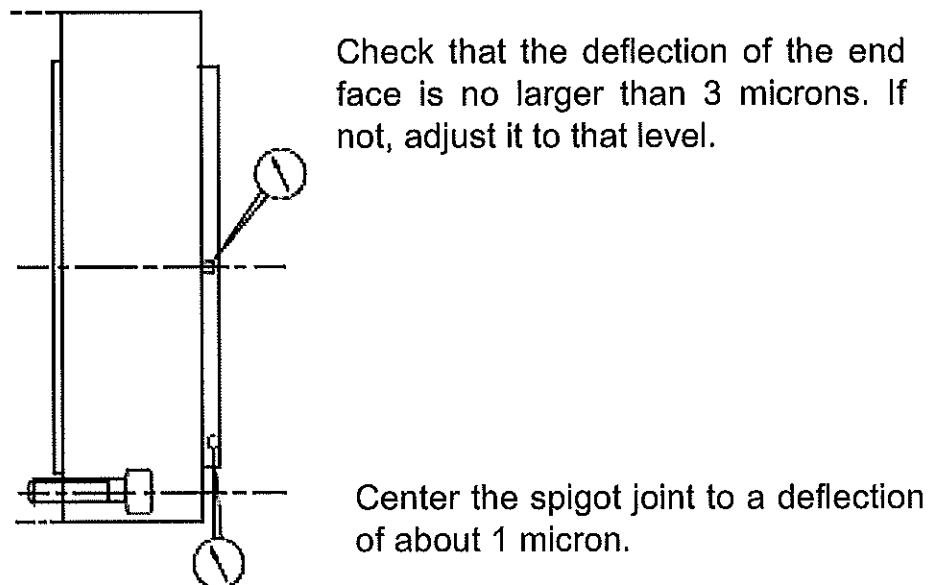

3. Attaching the actuator

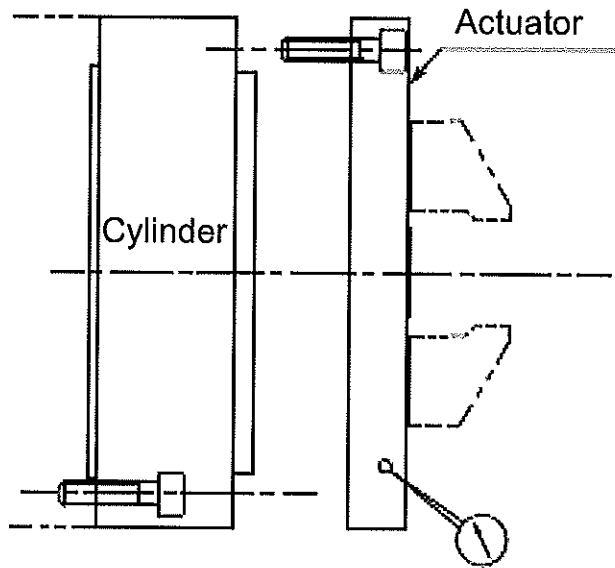

Attach the actuator and then check that it is centered to a deflection of no larger than about 5 microns.

Bolt Tightening Torque

Attaching bolts for actuator and cylinder (Note)

■ Tightening torque

M3: 23 kgf · cm

M4: 53 kgf · cm

M5: 105 kgf · cm

M6: 178 kgf · cm

(For the bolt strength classification, use 12.9.)

Note:

The cylinder attaching bolt is incorporated in the cylinder.
(For machining only)

Procedure for Replacing the Actuator

■ Removing the actuator

1. Shut off the air sent into the chuck.
(In a state that air pressure is not applied to either of the both ports.)
2. Remove the cap bolts used for fixing the actuator. Then, apply air pressure to the push-out side of the chuck. (For the A port in the operation system diagram and outer-diameter clamping, the unclamp side is used.) The actuator is pushed out about 1.5 mm.
3. Rotate the mating mark on the actuator from the (C) position to the (O) center position. The actuator comes off from the main body. After that, hold the actuator with hand and pull it out.

Note 1:

Do not use a screwdriver for this purpose. The actuator and the cylinder surface may be damaged, greatly affecting the restoration precision after replacement.

Note 2:

For the air circuit diagram, see page 23.

Note 3:

Be sure to perform the air cleaning to the replacing parts (actuator and cylinder spigot part) and at steps 1, 2, and 3 for attaching the actuator.

Note 4:

For replace procedure, see the photos on rear side of the catalog.

■ Attaching the actuator

1. Check that the piston has moved forward.
2. Mate the actuator with the (O) position of the cylinder and rotate them to the (C) position. Apply air pressure to the lead-in side. The actuator and the main body are engaged with each other.

Note:

At this time, check that the actuator and the cylinder are securely engaged with each other. Check that any debris are not pinched between them. Be careful not to cause your finger to be pinched between them.

3. Evenly tighten the bolts used for fixing the actuator.
4. Check for the deflection of the actuator's outer edge.
Perform centering if necessary. During a centering work, if the actuator cannot be centered adequately by using actuator attaching bolts, completely fix the cylinder and the actuator, and then perform a centering work with use of attaching bolts for the cylinder and the adapter (spindle).

For centering, be sure to use a plastic hammer.

※ See Section “Bolt tightening torque” as described on the previous page.

5. Supply air into the chuck. Check that the actuator drives normally.

Replace the actuator as describe above.

Using the Rotary Union

■ Attaching the rotary union

1. Attach a retainer to the spindle. Perform centering.
(No larger than 5 microns at position C.)
2. Securely screw in the rotary union.
(When a front adapter is used)
Perform a centering work with a front adapter. Screw in the rotary union.
3. Perform centering at the a-b positions of the rotary union.
(No larger than 2 microns.)
4. Securely insert 4 external piping hoses (5 hoses if a drain port is included.). Be sure to orient the drain port downward.
(FC type)
(For FE and FF types, see page 23.)
5. Check for a deflection at the specified number of revolutions.

■ Specifications

In a state that reliable attaching has been performed, it is possible to determine any specifications up to the maximum number of revolutions (indicated in a catalog) for each model.

Supply pressure to a rotary union shall be up to 0.5 MPa.
Permissible coolant pressure shall be up to 0.5 MPa.
Furthermore, supply oil mist as service air.

(ISO GV32 turbine oil, Type I)

<FC • FE-1000, 800, 600/FF-800>

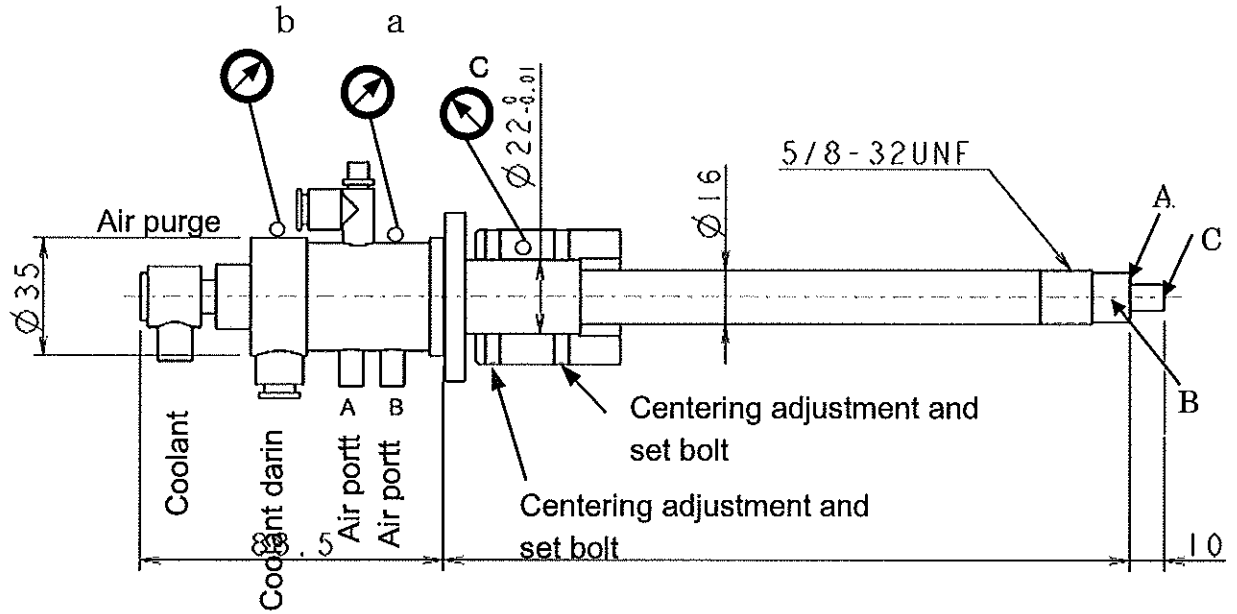

(For FE and FF types, see page 23.)

Air Purge of the Rotary Union

(A utility model application has been already filed.)

■ Setting up an air purge port (standard)

Supply mist air to the housing.

The main system is used to prevent coolant liquid from flowing into the rear bearings.

(Results)

Rotation anomaly and life deterioration are prevented.

The sub system is used to lubricate bearings.

(Results)

Cooling effect is enhanced during high-speed rotation.

■ Air purge conditions

The pressure of supply air shall be the same as a coolant pressure, or ensure that supply air pressure is at least 0.3 MPa. A flow rate in a speed controller shall be specified as 1.5 to 2.0 liter per minute prior to delivery to the customer. (It is possible to fabricate a high-pressure coolant of 1.0 MPa. However, it is necessary to separately determine the matter through mutual consultation.)

As the amount of drops of lubricants to a lubricator, a rate of about 2 to 3 drops per minute is appropriate.

Air Circuit Diagram

<FC/FE>

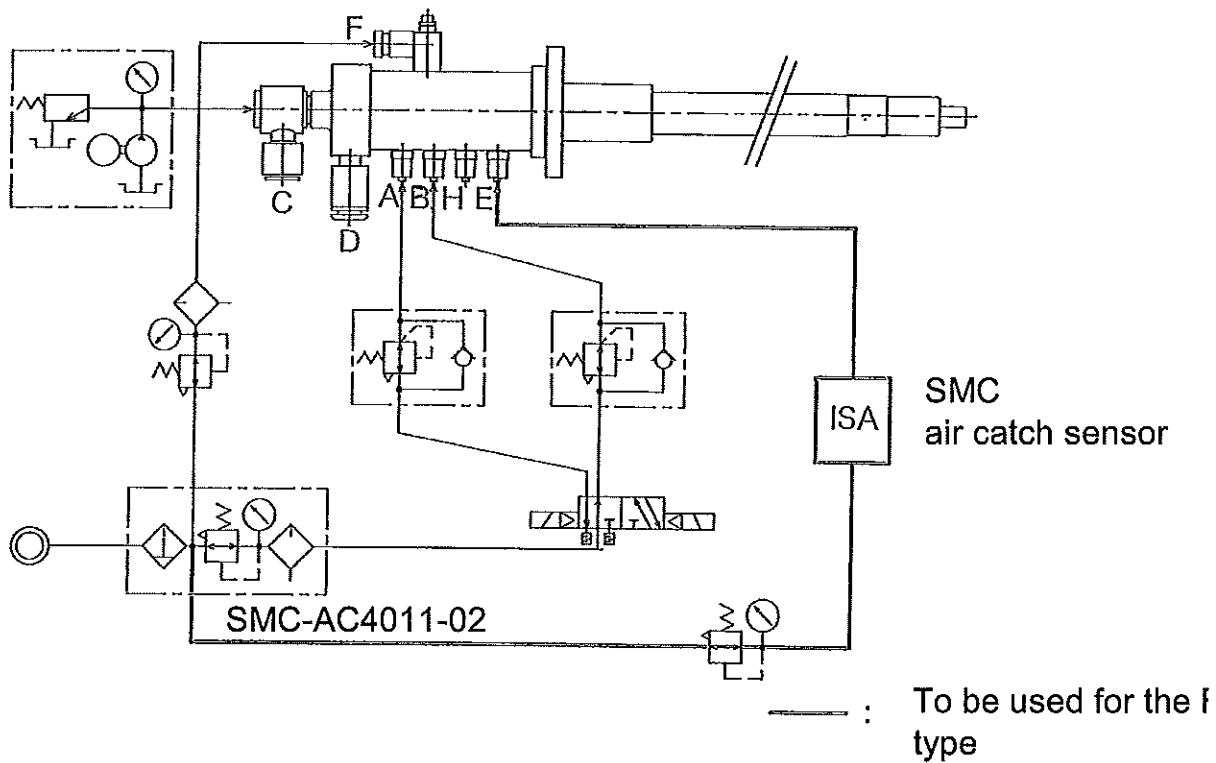

<FF>

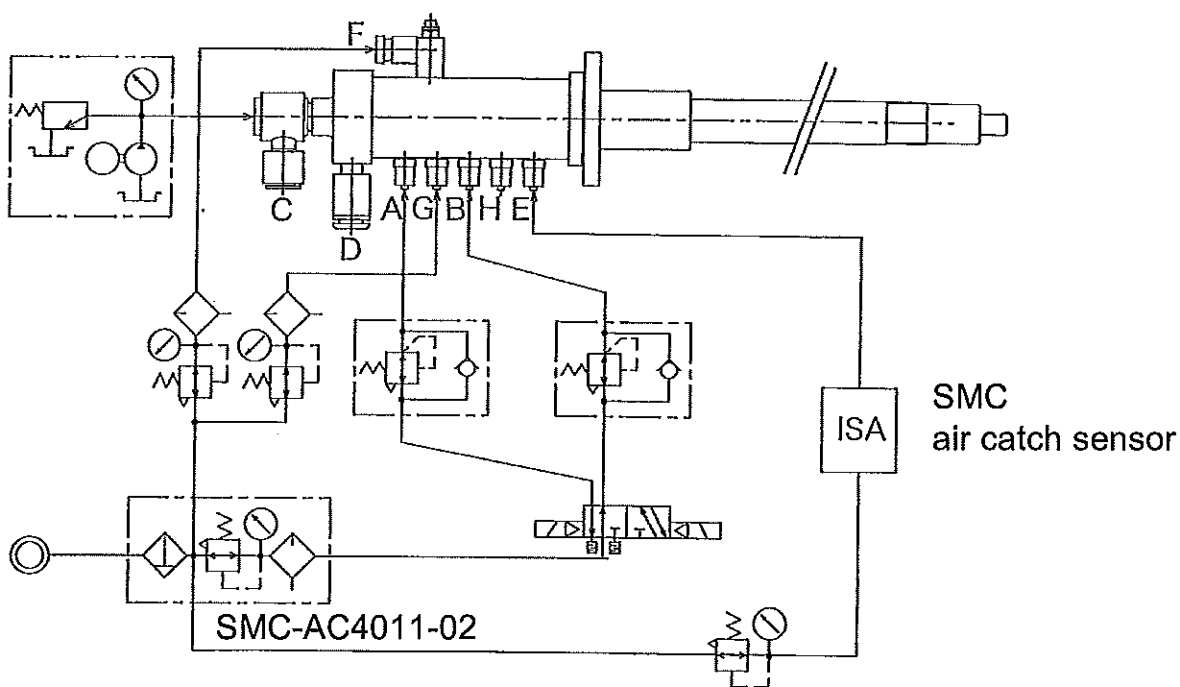

Precautions for Attaching the Rotary Union

Attach the MANO CLAMP and the rotary union as described on pages 16 through 22. It is recommended to use an optional exclusive-use retainer.

Be careful that bad centering may cause baking.

In particular, at the beginning of use, tighten bolts several times until the tightening bolts conform gently. Check for the deflection of the center.

Rotary bearings are precision bearings. Be sure to supply lubricating oil as oil fog.

When air piping is newly installed, cause lubricating oil to be released until it comes out of the mouth of a hose. After that, install piping to the F port and provide a mist flush.

Before using, check that lubricating oil is supplied at a rate of more than 3 drops per minute.

Avoid corrosive gas. Use clean dry air only.

Do not use oxidizing and reactive coolants.

Supply an air-mist purge port with the same pressure as a coolant pressure or the minimum 0.3 MPa. (The use of a high-pressure coolant at 1.0 MPa is determined separately through mutual consultation.)

Use a coolant pressure below a specified pressure (0.5 MPa). (The use of a high-pressure coolant at 1.0 MPa is determined separately through mutual consultation.)

Be sure to install an Air Control Unit.

Avoid a rapid temperature change. Set a working temperature at temperatures between 5 ° and 40 °.

(However, a lead-in pressure (increased force) is 0.6 MPa at the maximum.)

※ When starting a rotary union, perform running-in. Avoid rapid high-speed rotation.

500 rpm → 1000 rpm → 2000 rpm → 3000 rpm

A rotary union shall be rotated each time for more than 90 seconds.

As described above, increase the number of revolutions gradually, and check that there are not any reflection, vibrations, heating and abnormal noises.

For details, see a rotary union's catalog attached hereto.

Warranty of MANO CLAMP

The warranty period is one (1) year subject to the normal use.

The air supply pressure is 0.8 MPa maximum.

The use of 1,000,000 workpieces is warranted.

(However, a lead-in pressure (increased force) is 0.6 MPa at the maximum.)

※ The contents of this User's Manual are subject to change without prior notice for improvements to usage.

Troubleshooting

Symptom	Cause	Action
MANO CLAMP malfunction	Air supply is insufficient.	Check the supply pressure.
	A MANO CLAMP part is damaged.	The part must be repaired.
	The actuator is damaged.	Replace the actuator.
	The solenoid valve is damaged.	Replace the solenoid valve.
	The air tube is damaged.	Replace the air tube.
	The internal seal is worn out.	Replace the part.
	Foreign matter is included.	Overhaul MANO CLAMP.
Insufficient jaw stroke	A MANO CLAMP part is damaged.	Replace the part.
	The internal seal is worn out.	Overhaul MANO CLAMP.
Slipping workpiece of	MANO CLAMP malfunction items	Take action for each item.
	Cutting conditions have been changed.	Reduce the amount of cut-in.
	The shaped jaws are worn out.	Refinish or replace the jaws.
	The maximum number of revolutions is exceeded.	Reset the maximum number of revolutions to an appropriate value.
	If cutting conditions are changed.	Reduce the amount of cut-in.
Low machining precision	Workpiece elements (material and process)	Check the work elements to take the appropriate action.
	Mechanical elements	Check the mechanical elements to take an appropriate action.

If the above troubleshooting does not settle your problem, contact us.

Data Sheet for MANO CLAMP

■ Main body

User:

Product name:

Product drawing:

Model:

MANO CLAMP serial No.:

Actuator serial No.:

■ Jaw shaping

Supply pressure: [MPa]

Clamping diameter: [mm]

Finished dimensions: [mm]

Finishing pressure: [MPa]

Coaxial degree of jaws: [μ m]

For further details, refer to the specifications and product drawings.

This Instruction Manual is subject to change without notice.



6-6, Takaragaoka, Saidaji, Nara 631-0831, Japan

TEL: +81-742-46-4961 FAX: +81-742-46-5743

E-mail: info@nano-tech.co.jp

URL: <http://www.nano-tech.co.jp/>