

JETON[®]

www.jeton.com.tw

Vacuum Flex Tube
Adjustable Coolant Hoses



JETON[®]

www.jeton.com.tw

It is our great pleasure introducing JETON R/D & MFG. INC.

This is a company has more than 20 year's extensive experiences in the field of Injection Industrial and we major manufacture and market JETON ADJUSTABLE COOLANT HOSE, HIGH PRESSURE ADJUSTABLE NOZZLE, VACUUM FLEX TUBE, DOLL ARMATURE.

JETON is one of the leading manufacturers in INJECTION INDUSTRIAL from 1983 especially in ADJUSTABLE COOLANT HOSE for machine tools.

In 1989, we use the reason of COOLANT HOSE to develop the product for Doll in ARMATURE that could be put into the stuff toys or ceramic doll, soft body and so on. It's made the toy to be looked life-like very much.

In 1994, we extend the range of toy's accessory with great varieties.

In 1996, we use the modern techniques to combine and develop with flexible structuring parts for applications.

Nowadays we rename JETON R/D & MFG. INC. (Original: HONG CHYE INDUSTRIAL CO., LTD.) and hope you to support us in the future.



CONTENTS

Adjustable Coolant Hoses

Adjustable Coolant Hose Introduction.....	03
Length Calculation Method.....	05
Vacuum Flex Tube System.....	07
The Collocated Form of System and Accessories.....	09
System & Specification.....	21-24



Adjustable Coolant Hoses

Adjustable Coolant Hose Introduction

Length and angle can be freely adjusted, suitable for most fluids (liquids and gases), hose orifice can be changed as needed.
Can be used for air or for water/oil supply to metal processing machinery.

- ▶ Made using superior POM plastic steel; is strongly resistant to oils and chemicals.
- ▶ Adjustable Coolant Hose is highly pliable; it holds its shape well and will not spring back.
- ▶ Bending hose will not reduce inner diameter; hose will not pinch or fatigue.
- ▶ Adjustable Coolant Hose will not damage cutting blades if there is accidental contact.
- ▶ Adjustable Coolant Hose does not conduct electricity and is suitable for use on electrical discharge (EDM) machines.
- ▶ Five kinds of orifice inner diameter are available: 1/4", 3/8", 1/2", 3/4", 2 1/2".
- ▶ Adjustable Coolant Hose is designed for the transport of low-pressure fluids.

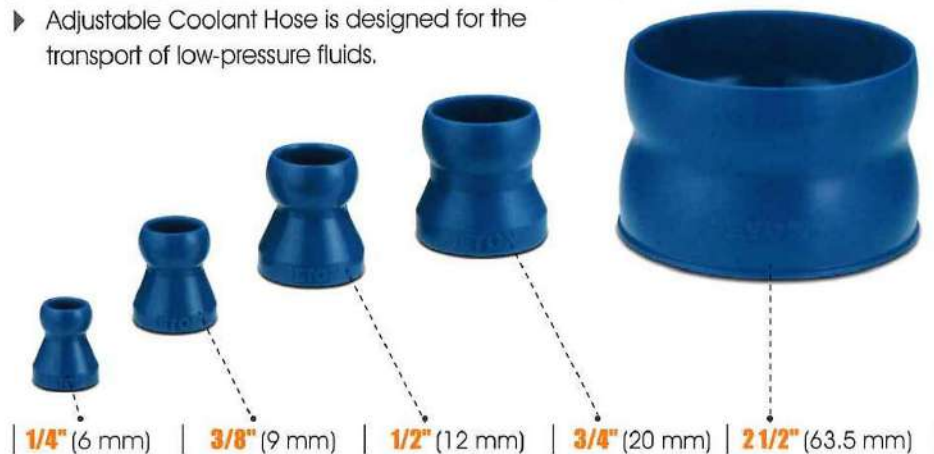

Hose Pressure and Flow Characteristics

1/4" SYSTEM	2.0~3.0 kg/cm ²	900 Liter / Hour
3/8" SYSTEM	2.0~3.0 kg/cm ²	1500 Liter / Hour
1/2" SYSTEM	1.4~2.0 kg/cm ²	1700 Liter / Hour
3/4" SYSTEM	0.7~1.4 kg/cm ²	1900 Liter / Hour

Recommended Usage

- ▶ When using Adjustable Coolant Hose, changes in the situation may affect the maximum pressure. It is recommended that tests be performed whenever changes are made.

Thermal Characteristics

- ▶ Melting point: 165° C
- ▶ Maximum use temperature: 65° C

Adjustable Coolant Hose Packaging

Adjustable Coolant Hose is available in cardboard boxes, bags, and coils to meet customers' specific needs.



LIST OF SUITABLE FLUIDS

Ordinary Adjustable Coolant Hoses are manufactured from acetal . Hose is available in dark blue and orange colors.

ITEM	SUITABLE	UNSUITABLE
ALCOHOLS, ETHYL	○	
ACETONE	○	
COMMERCIAL DISHDETERGENTS	○	
GASOLINE	○	
GREASES	○	
LACQUER SOLVENTS	○	
OILS	○	
SODIUM HYDROXIDE	○	
INSECTICIDES	○	
BRAKE OILS	○	
ACIDS		×
BASES, STRONG		×
AMMONIUM HYDROXIDE(STRONG)		×
HYPOCHLORITE ION SOLUTIONS		×
SODIUM HYPOCHLORITE		×

omnipotent
Adjustable Coolant
Hose Packaging



Length Calculation Method

Adjustable Coolant Hoses Length Calculation Method Sample Calculations



$$\text{Connector Size (A)} + \text{Effective Hose Size (B x Number of inter locking pieces)} + \text{Nozzle (C)} = \text{Total Length}$$

- ▶ **1/4"** 10.2 mm + 14.8 mm x Number of hoses + 35.2 mm = Total length
- ▶ **3/8"** 12.7 mm + 17.3 mm x Number of hoses + 39.2 mm = Total length
- ▶ **1/2"** 14.8 mm + 21.1 mm x Number of hoses + 37.8 mm = Total length
- ▶ **3/4"** 14.2 mm + 23.7 mm x Number of hoses + 43.0 mm = Total length

Installation of Adjustable Coolant Hoses

It's simple and easy to install Adjustable Coolant Hoses using the special pliers. The pliers can also be used to take apart the hose.

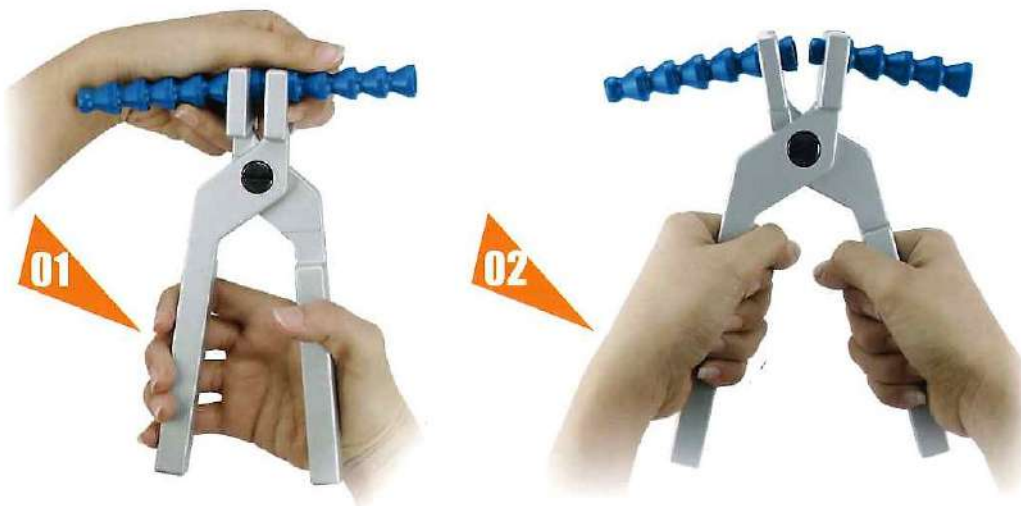

Total Flow Control Unit

The Total Flow Control Unit can be installed on all types of mechanical equipment to control of water flow. It is easy to install and makes machine more aesthetically attractive. Ensures convenient flow control.

JTM-01 CONTROL UNIT

- Total Flow Control Unit 1 set
- 1/4" Adjustable Coolant Hoses & Valves Unit 1 set
- 3/8" Adjustable Coolant Hoses & Valves Unit 3 set

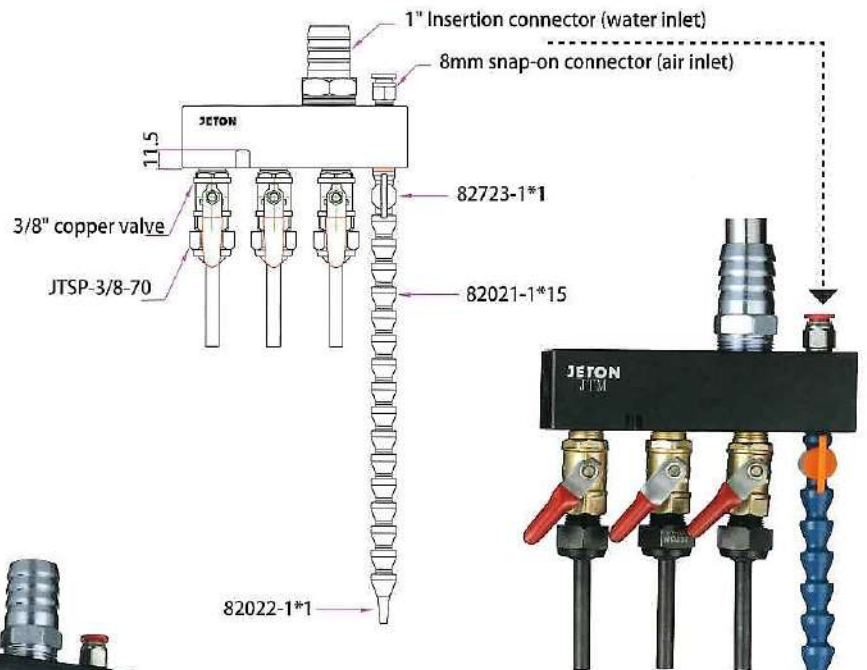
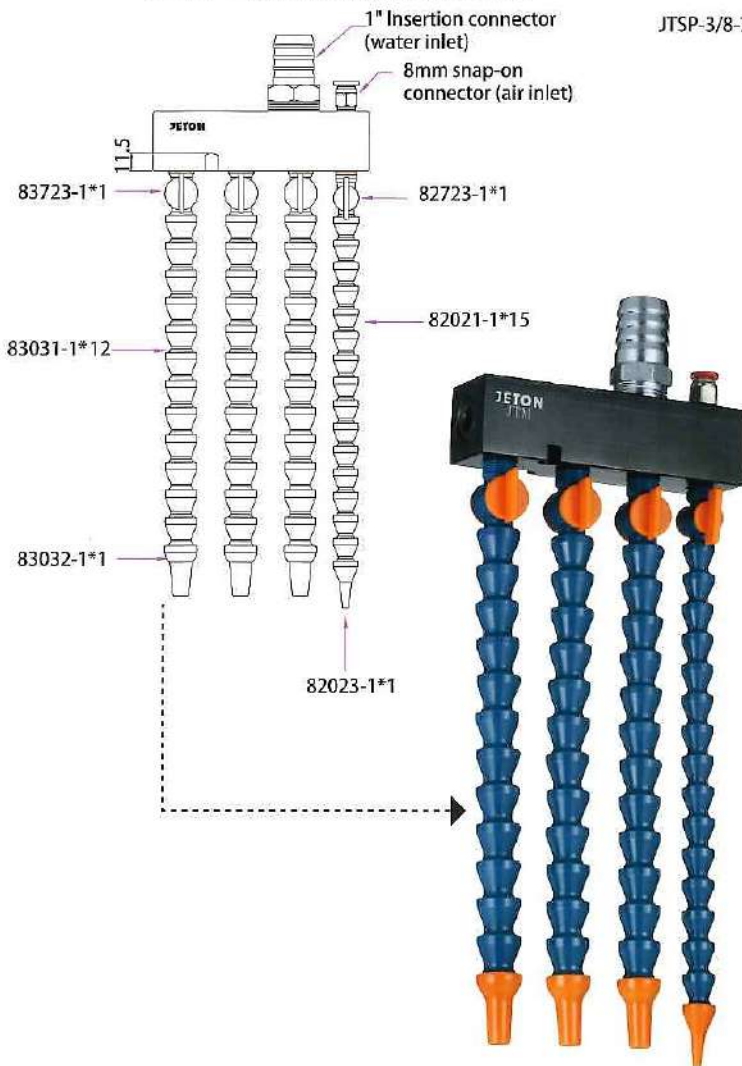
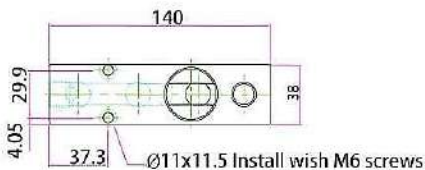

JTM-02 CONTROL UNIT

- Total Flow Control Unit 1 set
- 1/4" Adjustable Coolant Hoses & Valves Unit 1 set
- High Pressures Adjustable Nozzle 3 set

Total Flow Control Unit



Vacuum Flex Tube System 2 1/2" Inside Diameter

Picture	Item	Description
	89091	Vacuum Segment Packs, 9 Elements 2.5" ID
	89191	Vacuum Segment Packs, 18 Elements 2.5" ID
	89291	Vacuum Segment Packs, 180 Elements 2.5" ID

	89094	4.5" Round Nozzle, pack of 1
	89194	4.5" Round Nozzle, pack of 10

	89092	6" x 3.5" Rectangular Nozzle, pack of 1
	89192	6" x 3.5" Rectangular Nozzle, pack of 10

	89093	Tapered Oval Nozzle, pack of 1
	89193	Tapered Oval Nozzle, pack of 10

	89722	2.5" Slide Valve, pack of 1
	89742	2.5" Slide Valve, pack of 10

	89096	Shop Vacuum Hose Adapter with Mounting Tab, pack of 1
	89196	Shop Vacuum Hose Adapter with Mounting Tab, pack of 10

	89095	Shop Vacuum Adapter, pack of 1
	89195	Shop Vacuum Adapter, pack of 10

Picture	Item	Description
	89098	3" PVC Adapter, (Connect to 3" PVC Pipe) pack of 1
	89198	3" PVC Adapter, (Connect to 3" PVC Pipe) pack of 10

	89097	3" Sheet Metal Duct Adapter, (Connect to 3" Metal Duct) pack of 1
	89197	3" Sheet Metal Duct Adapter, (Connect to 3" Metal Duct) pack of 10

	89099	Shop Vacuum Adapter, pack of 1
	89199	Shop Vacuum Adapter, pack of 10

	89021	4" to 2.5" Shop Vacuum Adapter, pack of 1
	89121	4" to 2.5" Shop Vacuum Adapter, pack of 10

	89038	4" to 2.5" Y Reducer, pack of 1
--	--------------	---------------------------------

	89101	2.5" Fixed Base, pack of 1
---	--------------	----------------------------

	89102	4" to 2.5" Shop Vacuum Adapter Fixed Base, pack of 1
--	--------------	--

	89103	4" to 2.5" Y Reducer Fixed Base, pack of 1
--	--------------	--

Vacuum Flex Tube Features

This 2-1/2" vacuum flex tube is designed specifically for vacuum systems, and can be used for vacuuming dust, smoke, and particles. The tube's angle can be conveniently adjusted to reach every place within a work area. Length can also be adjusted to meet work needs. Several types of connectors and nozzles are also available, allowing users to select the most suitable setup. This 2 1/2" vacuum tube can be connected to a 3" PVC drainage pipe, 3" metal pipe, or a portable vacuum cleaner.

- ▶ The tube can be rotated 360°; angle is easily adjusted. Can be attached in an ideal working location.
- ▶ Durable, compression-resistant, wear-resistant.
- ▶ Made using superior DuPont plastic material; resistant to most chemicals.
- ▶ Highly flexible; bending will not reduce the inner diameter.
- ▶ Bending radius is approximately 145 mm.

TEMPERATURE SPECIFICATIONS

- ▶ Melting point: 165° C
- ▶ Maximum use temperature: 65° C

WARNING

- ▶ These vacuum flex tubes are made from plastic material. This material is highly flammable and must be kept away from sources of flame in order to prevent fire.

Vacuum Flex Tube



1/4" SYSTEM

▶ Male & Female Connector

82025
1/8" PT Connector 

82026
1/4" PT Connector 

82013
5/8" Female UNF Connector 

82014
7/16" Female UNF Connector 

82723
1/4" Male PT Valve 

82724
1/4" Female PT Valve 

▶ Polymorphic Connector

82028
1/4" Y Fitting 

82011
1/4" Double Socket 

82220
1/4" Extended Element Kit with Element Clamp 

62420
1/4" Elbow Fitting 

62422
1/4" Side Flow Nozzle 

62424
1/4" End Cap 

62426
1/4" T Fitting 

82722
1/4" Connection Valve 

82725
1/4" In-Line Check Valve 

▶ Nozzle

82029
1/4" PT Connector 

82012
1/4" Socket to 1/8" NPT 

82052
1/4" Female PT Connector 

82062
1/4" Female NPTF Connector 

82054
1/4" Flat Slot 40 Nozzle 

82055
1/4" Flat Slot 60 Nozzle 

82056
1/4" Flat 7 Hole Nozzle 

82057
1/4" Flat 5 Hole Nozzle 

82053
1" Straight Flow Nozzle 

82227
2-1/2" Swivel Nozzle 75 

82022
1/16" Round Nozzle 

82023
1/8" Round Nozzle 

82024
1/4" Round Nozzle 

82223
1/16" 90° Nozzle 

82224
1/8" 90° Nozzle 

82225
1/4" 90° Nozzle 

82226
1/4" 90° Spray Bar Nozzle 

82017
3/8" Flat Nozzle 

82027
1" Flare Nozzle 

82228
1/4" Swivel Nozzle 40 

82229
1/4" Swivel Nozzle 60 

3/8" SYSTEM

▶ Male & Female Connector

83035
3/8" PT Connector 

83036
1/2" PT Connector 

83026
1/4" PT Connector 

83723
3/8" Male PT Valve 

83724
3/8" Female PT Valve 

▶ Polymorphic Connector

83038
3/8" Y Fitting 

83011
3/8" Double Socket 

83651
3/8" to 1/4" Adapter 

83722
3/8" Connection Valve 

83725
3/8" In-Line Check Valve 

▶ Nozzle

83032
1/4" Round Nozzle 

83033
3/8" Round Nozzle 

83034
1/2" Round Nozzle 

83037
1-1/4" Flare Nozzle 

1/2" SYSTEM

▶ Male & Female Connector



▶ Polymorphic Connector



▶ Nozzle

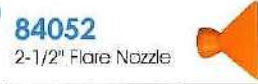

3/4" SYSTEM

▶ Male & Female Connector











































▶ Polymorphic Connector



▶ Nozzle



1/4" System (1/4" Inside Diameter)

Picture	Item	Description	Picture	Item	Description	Picture	Item	Description
	82020	1/4" Hose Kit 10 pcs of 1/4" Segment - 2 sets 1/16", 1/8", 1/4" Nozzles 1/4" & 1/8" Male PT Connectors		82326	1/4" 90° Nozzle Kit 1 Each: 1/16" 90° Nozzle 1/8" 90° Nozzle 1/4" 90° Nozzle 1/4" 90° Spray Bar Nozzle		82054	1/4" Flat Slot 40 Nozzle, pack of 2
	82020A	1/4" Hose Kit 10 pcs of 1/4" Segment - 2 sets 1/16", 1/8", 1/4" Nozzles 1/4" & 1/8" Male NPT Connectors		82022	1/16" Round Nozzle, pack of 4		82055	1/4" Flat Slot 60 Nozzle, pack of 2
	82220	1/4" Extended Element Kit Include 4 each of: 1/4" Extended Elements 1/4" Element Clamps		82042	1/16" Round Nozzle, pack of 50		82075	1/4" Flat Slot 60 Nozzle, pack of 20
	82021	1/4" Segment Pack 15 CM - 2 sets		82023	1/8" Round Nozzle, pack of 4		82076	1/4" Flat Slot 7 Hole Nozzle, pack of 20
	82051 82071	1/4" Segment Pack 1524 CM Coil 2500 CM Coil		82043	1/8" Round Nozzle, pack of 50		82056	1/4" Flat Slot 7 Hole Nozzle, pack of 2
	62423	1/4" Circle Flow Nozzle Kit Assembled with 15 pcs of 1/4" Side Flow Nozzles & 1 pc of 1/4" End Cap		82024	1/4" Round Nozzle, pack of 4		82057	1/4" Flat Slot 5 Hole Nozzle, pack of 2
	82221 82241	1/4" Extended Element, pack of 4 1/4" Extended Element, pack of 20		82044	1/4" Round Nozzle, pack of 50		82077	1/4" Flat Slot 5 Hole Nozzle, pack of 20
	82222 82242	1/4" Element Clamp, pack of 4 1/4" Element Clamp, pack of 20		82223	1/16" 90° Nozzle, pack of 4		82053	1" Straight Flow Nozzle, pack of 2
				82243	1/16" 90° Nozzle, pack of 20		82073	1" Straight Flow Nozzle, pack of 20
				82224	1/8" 90° Nozzle, pack of 4		82025	1/8" PT Connector, pack of 4
				82244	1/8" 90° Nozzle, pack of 20		82035	1/8" PT Connector, pack of 50
				82225	1/4" 90° Nozzle, pack of 4		82025A	1/8" NPT Connector, pack of 4
				82245	1/4" 90° Nozzle, pack of 20		82035A	1/8" NPT Connector, pack of 50
				82226	1/4" 90° Spray Bar Nozzle, pack of 2		82026	1/4" PT Connector, pack of 4
				82246	1/4" 90° Spray Bar Nozzle, pack of 20		82036	1/4" PT Connector, pack of 50
				82017	3/8" Flat Nozzle, pack of 2		82026A	1/4" NPT Connector, pack of 4
				82037	3/8" Flat Nozzle, pack of 20		82036A	1/4" NPT Connector, pack of 50
				82027	1" Flare Nozzle, pack of 2		82029	1/4" PT Connector, pack of 4
				82047	1" Flare Nozzle, pack of 20		82039	1/4" PT Connector, pack of 50







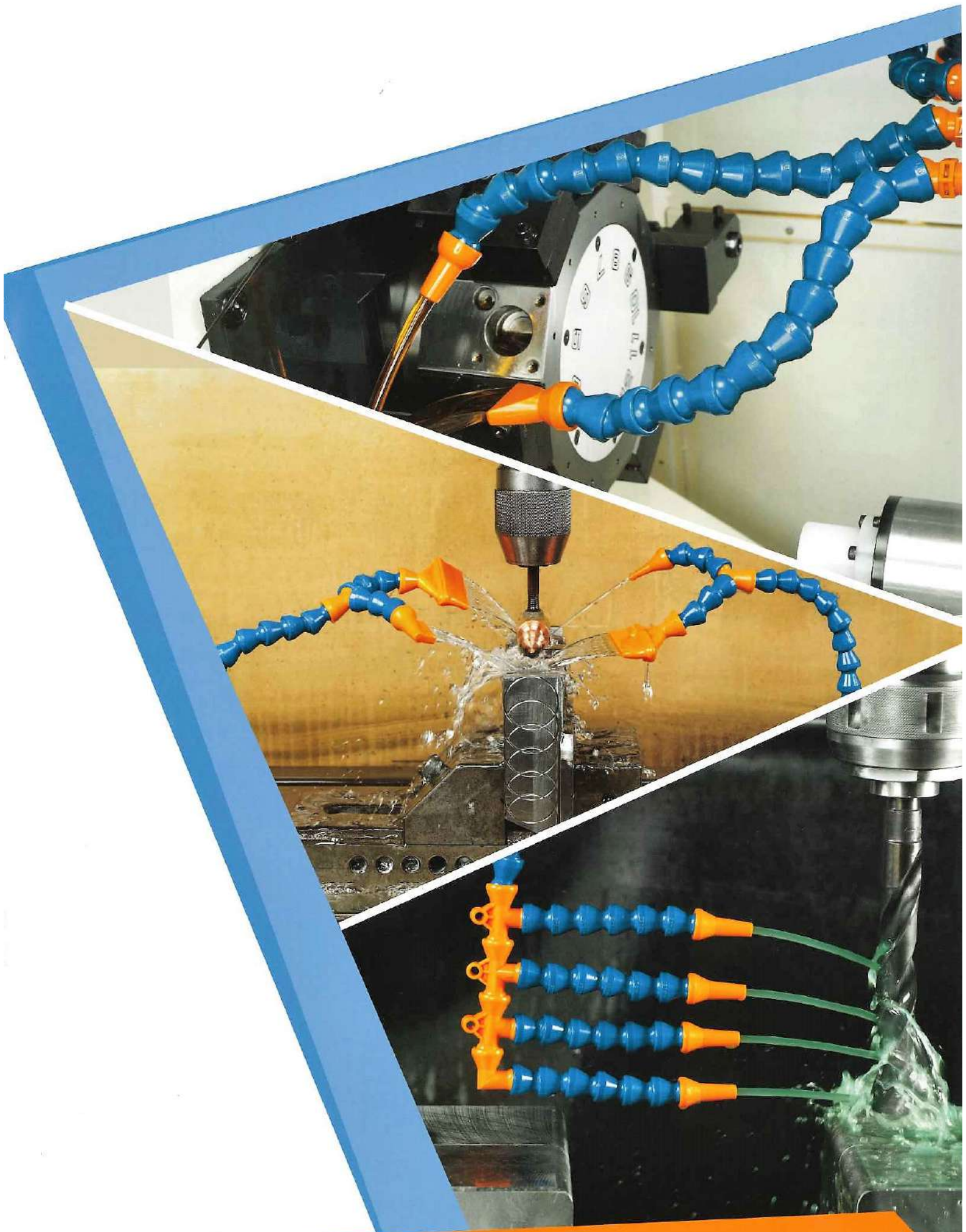

































Picture	Item	Description	Picture	Item	Description	Picture	Item	Description
	82028	1/4" Y Fitting, pack of 2		62422	1/4" Side Flow Nozzle, pack of 4		82723A	1/4" Male NPT Valve, pack of 2
	82038	1/4" Y Fitting, pack of 20		62442	1/4" Side Flow Nozzle, pack of 20		82733A	1/4" Male NPT Valve, pack of 10
	82011	1/4" Double Socket, pack of 4		62424	1/4" End Cap, pack of 4		82724	1/4" Female PT Valve, pack of 2
	82031	1/4" Double Socket, pack of 20		62444	1/4" End Cap, pack of 20		82744	1/4" Female PT Valve, pack of 10
	82012	1/4" Socket to 1/8" NPT, pack of 4		82227	2 1/2" Swivel Nozzle 75, pack of 2		82724A	1/4" Female NPT Valve, pack of 2
	82032	1/4" Socket to 1/8" NPT, pack of 20		82247	2 1/2" Swivel Nozzle 75, pack of 20		82744A	1/4" Female NPT Valve, pack of 10
	82052	1/4" Female PT Connector, pack of 4		82228	1/4" Swivel Nozzle 40, pack of 2		82725	1/4" In-Line Check Valve, pack of 2
	82072	1/4" Female PT Connector, pack of 50		82248	1/4" Swivel Nozzle 40, pack of 20		82745	1/4" In-Line Check Valve, pack of 10
	82052F	1/4" Female PF Connector, pack of 4		82229	1/4" Swivel Nozzle 60, pack of 2	 52400 1/4" Modular Manifold System 1/4" Elbow Fitting - 1 piece 1/4" Manifold Bracket - 1 piece 1/4" T Fitting - 3 pcs Mounting Screws - 3 pcs		
	82072F	1/4" Female PF Connector, pack of 50		82249	1/4" Swivel Nozzle 60, pack of 20			
	82062	1/4" Female NPTF Connector, pack of 4		82721A	1/4" NPT Male Hose Nipple Valve, pack of 2			
	82082	1/4" Female NPTF Connector, pack of 50		82731A	1/4" NPT Male Hose Nipple Valve, pack of 10			
	82013	5/8" Female UNF Connector, pack of 4		82722	1/4" Connection Valve, pack of 2	 52410 1/4" Main Flow Control Manifold System 1/4" Modular Manifold - 1 set 1/4" Connection Valve - 5 pcs		
	82033	5/8" Female UNF Connector, pack of 20		82732	1/4" Connection Valve, pack of 10			
	82014	7/16" Female UNF Connector, pack of 4		82723	1/4" Male PT Valve, pack of 2	 52416 1/4" Manifold Bracket, pack of 2		
	82034	7/16" Female UNF Connector, pack of 20		82733	1/4" Male PT Valve, pack of 10			
	62420	1/4" Elbow Fitting, pack of 2		62430	1/4" Elbow Fitting, pack of 20	 26171 1/4" Hose Assembly Pliers		
	62426	1/4" T Fitting, pack of 2		62436	1/4" T Fitting, pack of 20			
	62436	1/4" T Fitting, pack of 20						

3/8" System (3/8" Inside Diameter)

Picture	Item	Description	Picture	Item	Description	Picture	Item	Description
	83030	3/8" Hose Kit 8 pcs of 3/8" Segment - 2 sets 3/8" Nozzle 3/8" Male PT Connector		83032	1/4" Round Nozzle, pack of 4		83038	3/8" Y Fitting, pack of 2
	83030A	3/8" Hose Kit 8 pcs of 3/8" Segment - 2 sets 3/8" Nozzle 3/8" Male NPT Connector		83052	1/4" Round Nozzle, pack of 50		83058	3/8" Y Fitting, pack of 20
	83430	3/8" Hose Kit 8 pcs of 3/8" Segment - 2 pcs 1/4", 3/8", 1/2" Nozzles 3/8" & 1/2" Male PT Connectors		83033	3/8" Round Nozzle, pack of 4		83011	3/8" Double Socket, pack of 4
	83430A	3/8" Hose Kit 8 pcs of 3/8" Segment - 2 pcs 1/4", 3/8", 1/2" Nozzles 3/8" & 1/2" Male NPT Connectors		83053	3/8" Round Nozzle, pack of 50		83041	3/8" Double Socket, pack of 20
	83031	3/8" Segment Pack 14.5 CM - 2 sets		83034	1/2" Round Nozzle, pack of 4		83725	3/8" In-Line Check Valve, pack of 2
	83051	3/8" Segment Pack 762 CM Coil		83054	1/2" Round Nozzle, pack of 50		83745	3/8" In-Line Check Valve, pack of 10
	83091	3/8" Segment Pack 1524 CM Coil		83026	1/4" PT Connector, pack of 4		83651	3/8" to 1/4" Adapter, pack of 2
				83046	1/4" PT Connector, pack of 50		83851	3/8" to 1/4" Adapter, pack of 20
				83035	3/8" PT Connector, pack of 4		83722	3/8" Connection Valve, pack of 2
				83055	3/8" PT Connector, pack of 50		83742	3/8" Connection Valve, pack of 10
				83035A	3/8" NPT Connector, pack of 4		83723	3/8" Male PT Valve, pack of 2
				83055A	3/8" NPT Connector, pack of 50		83743	3/8" Male PT Valve, pack of 10
				83036	1/2" PT Connector, pack of 4		83723A	3/8" Male NPT Valve, pack of 2
				83056	1/2" PT Connector, pack of 50		83743A	3/8" Male NPT Valve, pack of 10
				83036A	1/2" NPT Connector, pack of 4		83724	3/8" Female PT Valve, pack of 2
				83056A	1/2" NPT Connector, pack of 50		83744	3/8" Female PT Valve, pack of 10
				83037	1 1/4" Flare Nozzle, pack of 2		83724A	3/8" Female NPT Valve, pack of 2
				83057	1 1/4" Flare Nozzle, pack of 20		83744A	3/8" Female NPT Valve, pack of 10
							26176	3/8" Hose Assembly Pliers



1/2" System (1/2" Inside Diameter)

Picture	Item	Description	Picture	Item	Description	Picture	Item	Description
	84040	1/2" Hose Kit 6 pcs of 1/2" Segment - 2 sets 1/4", 3/8", 1/2" Nozzles 3/8", 1/2" Male PT Connectors		84346	90° Nozzle Kit 1 Each: 1/4" 90° Nozzle 3/8" 90° Nozzle 1/2" 90° Nozzle 1/2" 90° Spray Bar Nozzle		84054	1/2" Flat Slot-40 Nozzle, pack of 2
	84040A	1/2" Hose Kit 6 pcs of 1/2" Segment - 2 sets 1/4", 3/8", 1/2" Nozzles 3/8", 1/2" Male NPT Connectors					84074	1/2" Flat Slot 40 Nozzle, pack of 20
	84440	1/2" Extended Element Kit Includes 4 each of: 1/2" Extended Elements 1/2" Element Clamps		84044	1/4" Round Nozzle, pack of 4		84056	1/2" Flat Slot 7 Hole Nozzle, pack of 2
	84041	1/2" Segment Pack 13.5 CM - 2 sets		84064	1/4" Round Nozzle, pack of 50		84076	1/2" Flat Slot 7 Hole Nozzle, pack of 20
	84081 84091	1/2" Segment Pack 1524 CM Coil 2500 CM Coil		84042	3/8" Round Nozzle, pack of 4		84057	1/2" Flat Slot 5 Hole Nozzle, pack of 2
	64643	1/2" Circle Flow Nozzle Kit Assemble with 15 pcs of 1/2" Side Flow Nozzles & 1 pc of 1/2" End Cap		84062	3/8" Round Nozzle, pack of 50		84077	1/2" Flat Slot 5 Hole Nozzle, pack of 20
	84441 84461	1/2" Extended Element, pack of 4 1/2" Extended Element, pack of 20		84043	1/2" Round Nozzle, pack of 4		84058	1 1/4" Straight Flow Nozzle, pack of 2
	84442 84462	1/2" Extended Clamp, pack of 4 1/2" Extended Clamp, pack of 20		84063	1/2" Round Nozzle, pack of 50		84078	1 1/4" Straight Flow Nozzle, pack of 20
				84443	1/4" 90° Nozzle, pack of 4		84059	1 5/8" Straight Flow Nozzle, pack of 2
				84463	1/4" 90° Nozzle, pack of 20		84079	1 5/8" Straight Flow Nozzle, pack of 20
				84444	3/8" 90° Nozzle, pack of 4		84047	1 1/4" Flare Nozzle, pack of 2
				84464	3/8" 90° Nozzle, pack of 20		84067	1 1/4" Flare Nozzle, pack of 20
				84445	1/2" 90° Nozzle, pack of 4		84050	1 3/4" Flare Nozzle, pack of 2
				84465	1/2" 90° Nozzle, pack of 20		84070	1 3/4" Flare Nozzle, pack of 20
				84446	1/2" 90° Spray Bar Nozzle, pack of 2		84052	2 1/2" Flare Nozzle, pack of 2
				84466	1/2" 90° Spray Bar Nozzle, pack of 20		84072	2 1/2" Flare Nozzle, pack of 20

Picture	Item	Description
	84447	2 1/2" Swivel Nozzle 75 for 1/2", pack of 2
	84467	2 1/2" Swivel Nozzle 75 for 1/2", pack of 20

	84046	3/8" PT Connector, pack of 4
	84066	3/8" PT Connector, pack of 50

	84046A	3/8" NPT Connector, pack of 4
	84066A	3/8" NPT Connector, pack of 50

	84045	1/2" PT Connector, pack of 4
	84065	1/2" PT Connector, pack of 50

	84045A	1/2" NPT Connector, pack of 4
	84065A	1/2" NPT Connector, pack of 50

	84048	1/2" Y Fitting, pack of 2
	84068	1/2" Y Fitting, pack of 20

	84049	1/2" to 1/4" Y Reducer, pack of 2
	84069	1/2" to 1/4" Y Reducer, pack of 20

	84651	1/2" to 1/4" Adapter, pack of 2
	84851	1/2" to 1/4" Adapter, pack of 20

	84011	1/2" Double Socket, pack of 4
	84031	1/2" Double Socket, pack of 20

Picture	Item	Description
	64620	1/2" Elbow Fitting, pack of 2
	64640	1/2" Elbow Fitting, pack of 20

	64626	1/2" T Fitting, pack of 2
	64646	1/2" T Fitting, pack of 20

	64622	1/2" Side Flow Nozzle, pack of 4
	64642	1/2" Side Flow Nozzle, pack of 20

	64624	1/2" End Cap, pack of 4
	64644	1/2" End Cap, pack of 20

	84722	1/2" Connection Valve, pack of 2
	84742	1/2" Connection Valve, pack of 10

	84723	1/2" Male PT Valve, pack of 2
	84743	1/2" Male PT Valve, pack of 10

	84723A	1/2" Male NPT Valve, pack of 2
	84743A	1/2" Male NPT Valve, pack of 10

	84724	1/2" Female PT Valve, pack of 2
	84744	1/2" Female PT Valve, pack of 10

	84724A	1/2" Female NPT Valve, pack of 2
	84744A	1/2" Female NPT Valve, pack of 10

Picture	Item	Description
	84725	1/2" In-Line Check Valve, pack of 2
	84745	1/2" In-Line Check Valve, pack of 10

	84013	3/8" SAE Flare Nut Adapter(5/8"-18 Thread), pack of 4
	84033	3/8" SAE Flare Nut Adapter(5/8"-18 Thread), pack of 20

























	54400	1/2" Modular Manifold System 1/2" Elbow Fitting - 1 piece 1/2" Manifold Bracket - 1 piece 1/2" T Fitting - 3 pcs Mounting Screws - 3 pcs
---	--------------	--

	54410	1/2" Main Flow Control Manifold System 1/2" Modular Manifold - 1 set 1/2" Connection Valve - 5 pcs
---	--------------	--

	54416	1/2" Manifold Bracket, pack of 2
---	--------------	----------------------------------

	26172	1/2" Hose Assembly Pliers
---	--------------	---------------------------

3/4" SYSTEM (3/4" Inside Diameter)

Picture	Item	Description	Picture	Item	Description	Picture	Item	Description
	86060	3/4" Hose Kit 6 pcs of 3/4" Segment - 2 sets 5/8" & 3/4" Nozzles 3/4" Male PT Connector		86064A	3/4" NPT Connector, pack of 4		86011	3/4" Double Socket, pack of 4
				86074A	3/4" NPT Connector, pack of 50		86031	3/4" Double Socket, pack of 20
	86060A	3/4" Hose Kit 6 pcs of 3/4" Segment - 2 sets 5/8" & 3/4" Nozzles 3/4" Male NPT Connector		86021	3/4" Fixed Mount, pack of 2		66620	3/4" Elbow Fitting, pack of 2
							66640	3/4" Elbow Fitting, pack of 20
	86061	3/4" Segment Pack 15 CM - 2 sets		86022	3/4" Magnetic Base, pack of 1		86722	3/4" Connection Valve, pack of 2
							86742	3/4" Connection Valve, pack of 10
	86081	3/4" Segment Pack 1524 CM Coil		86023	Shield Mounting Elbow, pack of 2		86723	3/4" Male PT Valve, pack of 2
	86091	3/4" Segment Pack 2500 CM Coil					86743	3/4" Male PT Valve, pack of 10
	86063	5/8" Round Nozzle, pack of 4		86067	3" Flare Nozzle, pack of 2		86723A	3/4" Male NPT Valve, pack of 2
	86073	5/8" Round Nozzle, pack of 50		86077	3" Flare Nozzle, pack of 20		86743A	3/4" Male NPT Valve, pack of 10
	86062	3/4" Round Nozzle, pack of 4		86068	3/4" Y Fitting, pack of 2		86724	3/4" Female PT Valve, pack of 2
	86072	3/4" Round Nozzle, pack of 50		86078	3/4" Y Fitting, pack of 20		86744	3/4" Female PT Valve, pack of 10
	86062	3/4" Round Nozzle, pack of 4		86069	3/4" to 1/2" Y Reducer, pack of 2		86724A	3/4" Female NPT Valve, pack of 2
	86072	3/4" Round Nozzle, pack of 50		86079	3/4" to 1/2" Y Reducer, pack of 20		86744A	3/4" Female NPT Valve, pack of 10
	86064	3/4" PT Connector, pack of 4		86051	3/4" to 1/2" Adapter, pack of 2		26177	3/4" Hose Assembly Pliers
	86074	3/4" PT Connector, pack of 50		86071	3/4" to 1/2" Adapter, pack of 20			

Adjustable Coolant Hoses & Valves



62720 36cm Length Hose Kit

1/4" Male PT or NPT Valve	1 piece
20 pcs of 1/4" Segment	1 piece
1/16", 1/8" or 1/4" Round Nozzle	1 piece

1/4"

62721 36cm Length Hose Kit

1/4" Female PT or NPT Valve	1 piece
20 pcs of 1/4" Segment	1 piece
1/16", 1/8" or 1/4" Round Nozzle	1 piece



63720 36cm Length Hose Kit

3/8" Male PT or NPT Valve	1 piece
16 pcs of 3/8" Segment	1 piece
1/4", 3/8" or 1/2" Round Nozzle	1 piece

3/8"

63721 36cm Length Hose Kit

3/8" Female PT or NPT Valve	1 piece
16 pcs of 3/8" Segment	1 piece
1/4", 3/8" or 1/2" Round Nozzle	1 piece



64720 35cm Length Hose Kit

1/2" Male PT or NPT Valve	1 piece
12 pcs of 1/2" Segment	1 piece
1/4", 3/8" or 1/2" Round Nozzle	1 piece

1/2"

64721 35cm Length Hose Kit

1/2" Female PT or NPT Valve	1 piece
12 pcs of 1/2" Segment	1 piece
1/4", 3/8" or 1/2" Round Nozzle	1 piece



66720 40cm Length Hose Kit

3/4" Male PT or NPT Valve	1 piece
12 pcs of 3/4" Segment	1 piece
5/8" or 3/4" Round Nozzle	1 piece

3/4"

66721 40cm Length Hose Kit

3/4" Female PT or NPT Valve	1 piece
12 pcs of 3/4" Segment	1 piece
5/8" or 3/4" Round Nozzle	1 piece

Acid Resistant Hose System

1/4"

Item	Description	
1/4" Acid Resistant Segment Pack		
52021	14 cm	2 pcs
52051	1524 cm	1 coil
52071	2500 cm	1 coil
1/16" Acid Resistant Round Nozzle		
52022	pack of 4	
52042	pack of 50	
1/8" Acid Resistant Round Nozzle		
52023	pack of 4	
52043	pack of 50	
1/4" Acid Resistant Round Nozzle		
52024	pack of 4	
52044	pack of 50	
3/8" Acid Resistant Flare Nozzle		
52017	pack of 2	
52037	pack of 20	
1" Acid Resistant Flare Nozzle		
52027	pack of 2	
52047	pack of 20	
1/8" Acid Resistant PT Connector		
52025	pack of 4	
52035	pack of 50	
1/8" Acid Resistant NPT Connector		
52025A	pack of 4	
52035A	pack of 50	
1/4" Acid Resistant PT Connector		
52026	pack of 4	
52036	pack of 50	
1/4" Acid Resistant NPT Connector		
52026A	pack of 4	
52036A	pack of 50	
1/4" Acid Resistant PT Connector		
52029	pack of 4	
52039	pack of 50	
1/4" Acid Resistant Y Fitting		
52028	pack of 4	
52038	pack of 50	
1/4" Acid Resistant Double Socket		
52011	pack of 4	
52031	pack of 20	
1/4" Acid Resistant Elbow Fitting		
52420	pack of 2	
52430	pack of 20	
1/4" Acid Resistant T Fitting		
52426	pack of 2	
52436	pack of 20	

3/8"

Item	Description	
3/8" Acid Resistant Segment Pack		
53031	14.5 cm	2 pcs
53051	762 cm	1 coil
53091	1524 cm	1 coil
1/4" Acid Resistant Round Nozzle		
53032	pack of 4	
53052	pack of 50	
3/8" Acid Resistant Round Nozzle		
53033	pack of 4	
53053	pack of 50	
1/2" Acid Resistant Round Nozzle		
53034	pack of 4	
53054	pack of 50	
1/4" Acid Resistant PT Connector		
53026	pack of 4	
53046	pack of 50	
3/8" Acid Resistant PT Connector		
53035	pack of 4	
53055	pack of 50	
3/8" Acid Resistant NPT Connector		
53035A	pack of 4	
53055A	pack of 50	
1/2" Acid Resistant PT Connector		
53036	pack of 4	
53056	pack of 50	
1/2" Acid Resistant NPT Connector		
53036A	pack of 4	
53056A	pack of 50	
1-1/4" Acid Resistant Flare Nozzle		
53037	pack of 2	
53057	pack of 20	

1/2"

Item	Description	
1/2" Acid Resistant Segment Pack		
54041	14 cm	2 pcs
54081	1524 cm	1 coil
53091	2500 cm	1 coil
1/4" Acid Resistant Round Nozzle		
54044	pack of 4	
54064	pack of 50	
3/8" Acid Resistant Round Nozzle		
54042	pack of 4	
54062	pack of 50	
1/2" Acid Resistant Round Nozzle		
54043	pack of 4	
54063	pack of 50	
1-1/4" Acid Resistant Flare Nozzle		
54047	pack of 2	
54067	pack of 20	
1-3/4" Acid Resistant Flare Nozzle		
54050	pack of 2	
54070	pack of 20	
2-1/2" Acid Resistant Flare Nozzle		
54052	pack of 2	
54072	pack of 20	
3/8" Acid Resistant PT Connector		
54046	pack of 4	
54066	pack of 50	
3/8" Acid Resistant NPT Connector		
54046A	pack of 4	
54066A	pack of 50	
1/2" Acid Resistant PT Connector		
54045	pack of 4	
54065	pack of 50	
1/2" Acid Resistant NPT Connector		
54045A	pack of 4	
54065A	pack of 50	
1/2" Acid Resistant Y Fitting		
54048	pack of 2	
54068	pack of 20	
1/2" to 1/4" Acid Resistant Y Fitting		
54049	pack of 2	
54069	pack of 20	
1/2" to 1/4" Acid Resistant Adapter		
54651	pack of 2	
54851	pack of 20	
1/2" Acid Resistant Double Socket		
54011	pack of 4	
54031	pack of 20	
1/2" Acid Resistant Elbow Fitting		
54620	pack of 2	
54640	pack of 20	
1/2" Acid Resistant T Fitting		
54626	pack of 2	
54646	pack of 20	

LISTE OF SUITABLE FLUIDS

Acid Resistant Adjustable Coolant Hoses
Hose is Available in Gray Color

ITEM	SUITABLE	UNSUITABLE
ALCOHOLS, ETHYL	○	
ACIDS, (LESS THAN 65° C)	○	
GASOLINE	○	
GREASES	○	
HYDROCARBONS	○	
OILS	○	
SALT SOLUTIONS	○	
WATER (GREATER THAN 65° C)		X
ACIDS, (GREATER THAN 65° C)		X
ACETONE		X
AROMATIC SOLVENTS		X
CHLORINATED HYDROCARBON		X
ETHYL ACETATE		X
BASES, STRONG		X



Shield Board System



Shield Kit

34101 (6" x 8")

34102 (7-1/2" x 10")

34103 (8-1/2" x 12")

Magnetic Base	1 set
12 pcs of 3/4" Segment	1 piece
3/4" Shield Mounting Elbows	1 piece
3/4" Fixed Mount	1 piece
Nut	2 pcs
Acrylic Board	1 piece

Magnetic Base System



87011 Magnetic Set
(Magnetic Force On-Off)

Magnetic Base (W5xL6.5xH5 CM)	1 set
20 pcs of 1/4" Segment	3 pcs
1" Flare Nozzle	3 pcs
1/4" PT Connector	3 pcs
1/4" Copper Valve	3 pcs



87002 Magnetic Set
(Magnetic Force On-Off)

Magnetic Base (W5xL6.5xH5 CM)	1 set
20 pcs of 1/4" Segment	2 pcs
1" Flare Nozzle	2 pcs
1/4" PT Connector	2 pcs
1/4" Copper Valve	2 pcs



88005 Magnetic Set

Magnetic Base	1 set
10 pcs of 1/4" Segment	1 piece
1" Flare Nozzle	1 piece
1/4" Male PT Valve	1 piece



88003 Magnetic Set

Magnetic Base	1 set
10 pcs of 1/4" Segment	1 piece
1" Flare Nozzle	1 piece
1/4" PT Connector	1 piece



88105 Magnetic Set

Magnetic Base	1 set
20 pcs of 1/4" Segment	1 piece
1" Flare Nozzle	1 piece
1/4" Male PT Valve	1 piece

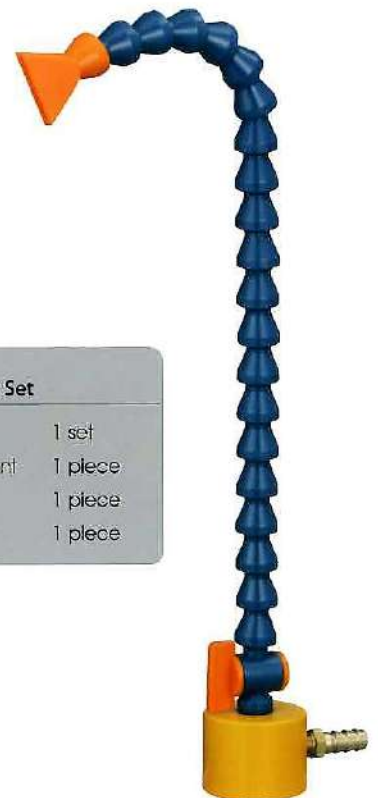

88103 Magnetic Set

Magnetic Base	1 set
20 pcs of 1/4" Segment	1 piece
1" Flare Nozzle	1 piece
1/4" PT Connector	1 piece

1/4" SYSTEM & SPECIFICATION

82021+82021		82022	82722	82226	62426
82025	82014	82023	82723	62423	
82026	82028	82024	82724	52416	82013
82029	82011	82223	82224	82228	
82012	62420	82725	82225	82229	
82052	82027	82017	82220	82227	
82053	82054	82055	82056	82057	

3/8" SYSTEM & SPECIFICATION

1/2" SYSTEM & SPECIFICATION

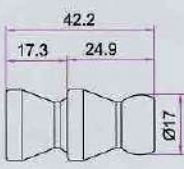
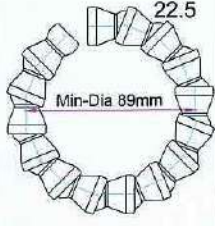
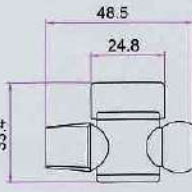
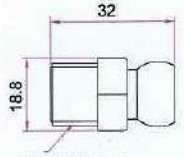
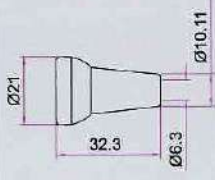
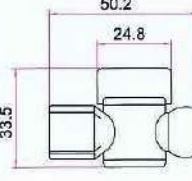
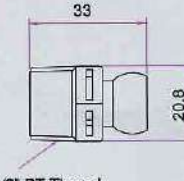
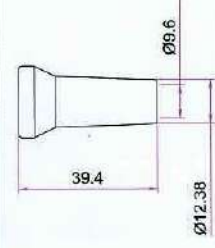
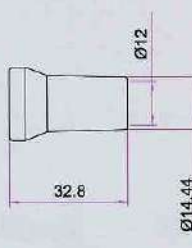
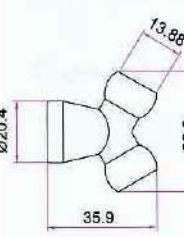
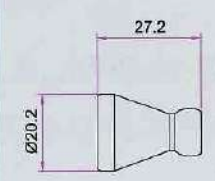
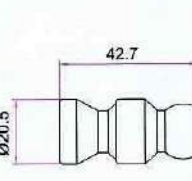
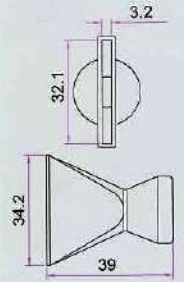
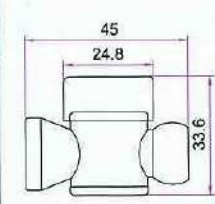
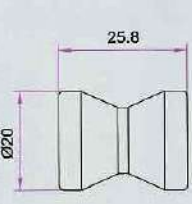
 <p>83031+83031</p>	 <p>Maximum Bending Angle : 22.5°</p>	 <p>83723</p>
 <p>3/8" PT Thread</p> <p>83035</p>	 <p>83032</p>	 <p>83724</p>
 <p>1/2" PT Thread</p> <p>83036</p>	 <p>83033</p>	 <p>83034</p>
 <p>83038</p>	 <p>83651</p>	 <p>83725</p>
 <p>83037</p>	 <p>83722</p>	 <p>83011</p>

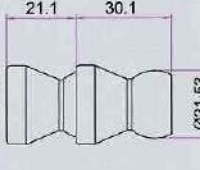
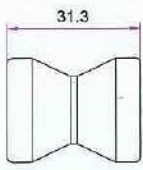
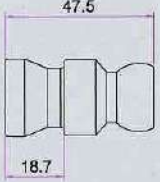
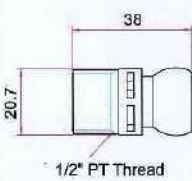
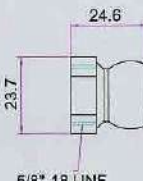
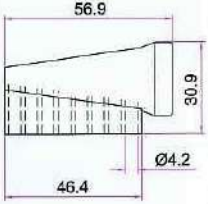
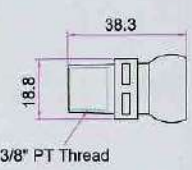
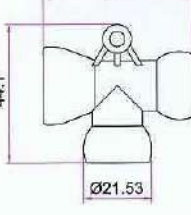
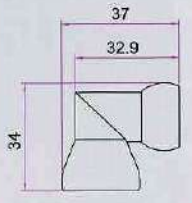
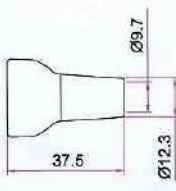
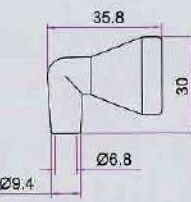
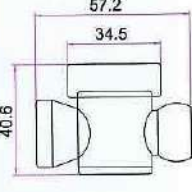
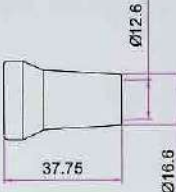
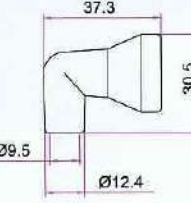
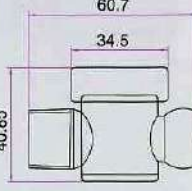
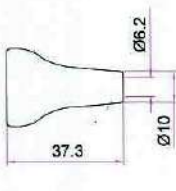
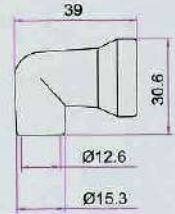
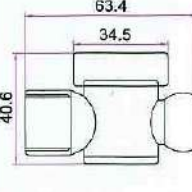
 <p>84041+84041</p>	 <p>84011</p>	 <p>84725</p>
 <p>1/2" PT Thread</p> <p>84045</p>	 <p>5/8"-18 UNF</p> <p>84013</p>	 <p>84446</p>
 <p>3/8" PT Thread</p> <p>84046</p>	 <p>84626</p>	 <p>64620</p>
 <p>84042</p>	 <p>84442</p>	 <p>84722</p>
 <p>84043</p>	 <p>84443</p>	 <p>84723</p>
 <p>84044</p>	 <p>84445</p>	 <p>84724</p>

1/2" SYSTEM & SPECIFICATION

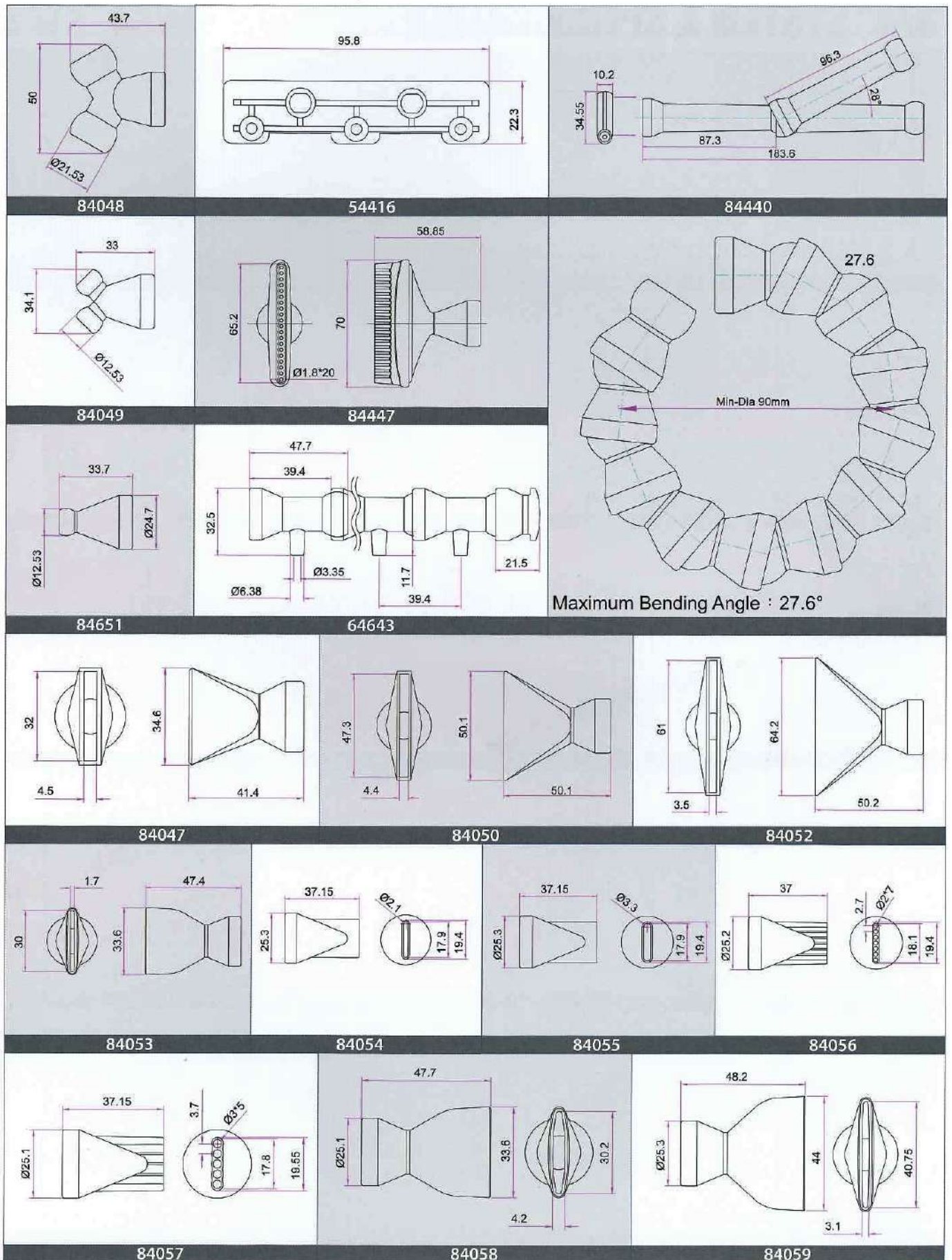

3/4" SYSTEM & SPECIFICATION

86061+86061	86011	86021	86022
86023	86064	86051	86067
86062	86063	86068	86069
<p>21</p> <p>Min-Dia 129mm</p> <p>Maximum Bending Angle : 21°</p>			
		66620	86722
		86723	86724

2 1/2" SYSTEM & SPECIFICATION

<p>89091+89091</p>	<p>89092</p>	<p>89099</p>	<p>89094</p>
<p>89095</p>	<p>89096</p>	<p>89097</p>	<p>89098</p>
<p>89722</p>	<p>89093</p>	<p>89101</p>	<p>89038</p>
<p>89103</p>	<p>89099</p>	<p>89021</p>	
<p>89101</p>	<p>89102</p>		



株式会社 ナノテック

〒631-0831 奈良市西大寺宝ヶ丘6番6号
TEL(0742)46-4961 FAX(0742)46-5743